

Snap-action Microswitches – Subminiature V4NC

V4NC

- Characteristics**
- Peg mounting option
 - Solder terminals
 - 2.8 mm faston (quick connect) terminals
 - PCB terminals
 - Sealed (IP 67) / unsealed (IP 40)
 - Pre-wired option
 - Snap-on terminal covers

Rating 250 VAC, 5 A

Dimensions (mm) V4NC 20 x 10.3 x 6.4
V4NCS 20 x 16.4 x 6.4

Actuator Plunger, plain levers, roller levers

Approvals None



Preferred Product Range

Ordering Reference	Actuating Force (N)	Actuating Force (oz)	Sealing	Operating pos. (mm)	Operating pos. (in)	Terminal	Circuit	Actuator	Contacts	Electrical rating
V4NCT7	1.7	6.114	Not sealed	8.40	0.33	Solder	CO	Plunger	Fine silver	250 VAC, 5 A
V4NCT7A1	0.8	2.877	Not sealed	10.85	0.43	Solder	CO	Plain lever	Fine silver	250 VAC, 5 A
V4NCT7AR1	0.8	2.877	Not sealed	16.00	0.63	Solder	CO	Roller lever	Fine silver	250 VAC, 5 A
V4NCSK2	2.5	8.992	Sealed IP 6K7	8.40	0.33	Cable 500 mm	CO	Plunger	Fine silver	250 VAC, 5 A
V4NCSK2A1	0.9	3.237	Sealed IP 6K7	10.80	0.43	Cable 500 mm	CO	Plain lever	Fine silver	250 VAC, 5 A
V4NCSK2AR1	0.9	3.237	Sealed IP 6K7	15.90	0.63	Cable 500 mm	CO	Roller lever	Fine silver	250 VAC, 5 A
V4NCSK2	2.5	8.992	Sealed IP 6K7	8.40	0.33	Cable 500 mm	CO	Plunger	Fine silver	250 VAC, 5 A
V4NCSK2A1	0.9	3.237	Sealed IP 6K7	10.80	0.43	Cable 500 mm	CO	Plain lever	Fine silver	250 VAC, 5 A
V4NCSK2AR1	0.9	3.237	Sealed IP 6K7	15.90	0.63	Cable 500 mm	CO	Roller lever	Fine silver	250 VAC, 5 A

Snap-action Microswitches – Subminiature V4NC

Specifications

Housing	Glass fiber reinforced Polyamide (PA 6.6)
Plunger	Polyacetal POM/(PA 4.6)
Mechanism	Snap-action coil spring mechanism with stainless steel spring
Functions	Change-over, normally-closed or normally-open
Contacts	Fine Silver, Gold plate on silver, Gold alloy on silver palladium (crosspoint)
Terminals	Gold flashed
Temperature range °C	-40°C to +85°C/120°C
Mechanical life	5 x 10 ⁶ cycles minimum (impact free actuation)
Protection	IP 40, IP 6K7, Flux-proof terminal entries (depend on type)
Mounting	Side mounting (molded mounting pegs on request)
Actuators	Plain lever, cam follower, roller lever, simulated roller (cam follower) lever
Accessories	Lug mounting frame, clip-on terminals cover, insulating sheet

Circuit diagram V4NCT7

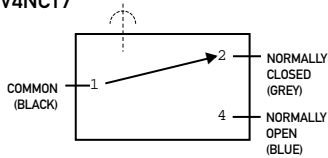

Dimensions (mm)

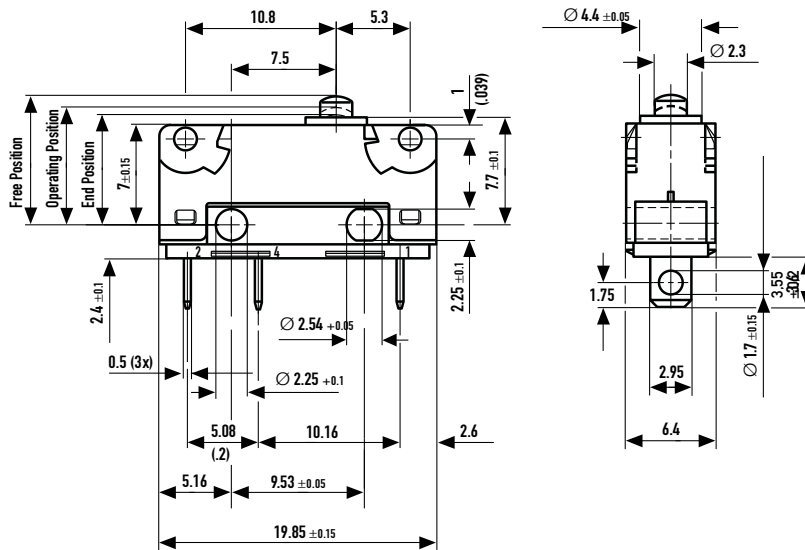

Snap-action Microswitches – Subminiature V4NC

Operating Characteristics

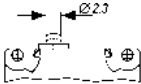
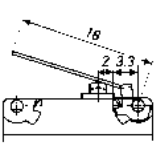
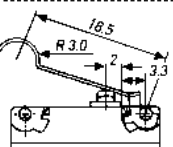
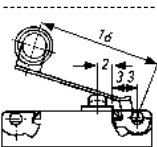
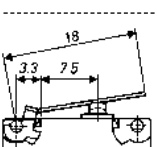
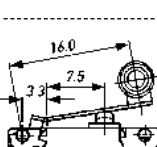
Actuator	Reference	Actuating Force		Release Force		Free Position		Operating Position		Movement Differential	
		Maximum (N)	(oz)	Minimum (N)	(oz)	(mm)	(in)	(mm)	(in)	Maximum (mm)	(in)
 Plunger (mm)	V4NC..	1.7	6.114	0.3	1.079	9.2 ± 0.3	0.362 ± 0.012	8.4 ± 0.3	0.331 ± 0.012	0.1	0.004
	V4NC4..	2.5	8.992	0.5	1.798	9.2 ± 0.3	0.362 ± 0.012	8.4 ± 0.3	0.331 ± 0.012	0.1	0.004
	V4NCE..	1.7	6.114	0.3	1.079	9.7 ± 0.3	0.382 ± 0.012	8.9 ± 0.3	0.35 ± 0.012	0.1	0.004
	V4NC4E..	2.5	8.992	0.5	1.798	9.7 ± 0.3	0.382 ± 0.012	8.9 ± 0.3	0.35 ± 0.012	0.1	0.004
	V4NCS..	2.5	8.992	0.5	1.798	9.2 ± 0.3	0.362 ± 0.012	8.4 ± 0.3	0.331 ± 0.012	0.1	0.004
	V4NC4S..	2.8	10.071	0.7	2.517	9.2 ± 0.3	0.362 ± 0.012	8.4 ± 0.3	0.331 ± 0.012	0.1	0.004
	V4NCSE..	2.5	8.992	0.5	1.798	9.7 ± 0.3	0.382 ± 0.012	8.9 ± 0.3	0.35 ± 0.012	0.1	0.004
	V4NC4SE..	2.8	10.071	0.7	2.517	9.7 ± 0.3	0.382 ± 0.012	8.9 ± 0.3	0.35 ± 0.012	0.1	0.004
 A1 Lever (mm)	V4NC..	0.8	2.877	0.07	0.251	13.4 ± 1.3	0.527 ± 0.051	10.85 ± 1.3	0.427 ± 0.051	0.4	0.016
	V4NC4..	1.1	3.956	0.1	0.359	13.4 ± 1.3	0.527 ± 0.051	10.85 ± 1.3	0.427 ± 0.051	0.4	0.016
	V4NCE..	0.8	2.877	0.07	0.251	14.8 ± 1.3	0.582 ± 0.051	12.4 ± 1.3	0.488 ± 0.051	0.4	0.016
	V4NC4E..	1.1	3.956	0.1	0.359	14.8 ± 1.3	0.582 ± 0.051	12.4 ± 1.3	0.488 ± 0.051	0.4	0.016
	V4NCS..	0.9	3.237	0.1	0.359	13.4 ± 1.3	0.527 ± 0.051	10.8 ± 1.3	0.425 ± 0.051	0.4	0.016
	V4NC4S..	1.1	3.956	0.15	0.539	13.4 ± 1.3	0.527 ± 0.051	10.8 ± 1.3	0.425 ± 0.051	0.4	0.016
	V4NCSE..	0.9	3.237	0.1	0.359	14.8 ± 1.3	0.582 ± 0.051	12.4 ± 1.3	0.488 ± 0.051	0.4	0.016
	V4NC4SE..	1.1	3.956	0.15	0.539	14.8 ± 1.3	0.582 ± 0.051	12.4 ± 1.3	0.488 ± 0.051	0.4	0.016
 AC1 Lever (mm)	V4NC..	0.8	2.877	0.07	0.251	16.1 ± 1.3	0.634 ± 0.051	13.5 ± 1.3	0.531 ± 0.051	0.4	0.016
	V4NC4..	1.1	3.956	0.1	0.359	16.1 ± 1.3	0.634 ± 0.051	13.5 ± 1.3	0.531 ± 0.051	0.4	0.016
	V4NCE..	0.8	2.877	0.07	0.251	17.6 ± 1.3	0.693 ± 0.051	15.1 ± 1.3	0.594 ± 0.051	0.4	0.016
	V4NC4E..	1.1	3.956	0.1	0.359	17.6 ± 1.3	0.693 ± 0.051	15.1 ± 1.3	0.594 ± 0.051	0.4	0.016
	V4NCS..	0.9	3.237	0.1	0.359	16.1 ± 1.3	0.634 ± 0.051	13.4 ± 1.3	0.527 ± 0.051	0.4	0.016
	V4NC4S..	1.1	3.956	0.15	0.539	16.1 ± 1.3	0.634 ± 0.051	13.4 ± 1.3	0.527 ± 0.051	0.4	0.016
	V4NCSE..	0.9	3.237	0.1	0.359	17.6 ± 1.3	0.693 ± 0.051	15.1 ± 1.3	0.594 ± 0.051	0.4	0.016
	V4NC4SE..	1.1	3.956	0.15	0.539	17.6 ± 1.3	0.693 ± 0.051	15.1 ± 1.3	0.594 ± 0.051	0.4	0.016
 AR1 Lever (mm)	V4NC..	0.8	2.877	0.07	0.251	18.1 ± 1.2	0.712 ± 0.047	16 ± 1.2	0.63 ± 0.047	0.4	0.016
	V4NC4..	1.2	4.316	0.1	0.359	18.1 ± 1.2	0.712 ± 0.047	16 ± 1.2	0.63 ± 0.047	0.4	0.016
	V4NCE..	0.8	2.877	0.07	0.251	19.2 ± 1.2	0.756 ± 0.047	17.3 ± 1.2	0.681 ± 0.047	0.4	0.016
	V4NC4E..	1.2	4.316	0.1	0.359	19.2 ± 1.2	0.756 ± 0.047	17.3 ± 1.2	0.681 ± 0.047	0.4	0.016
	V4NCS..	0.9	3.237	0.1	0.359	18.1 ± 1.2	0.712 ± 0.047	15.9 ± 1.2	0.626 ± 0.047	0.4	0.016
	V4NC4S..	1.2	4.316	0.15	0.539	18.1 ± 1.2	0.712 ± 0.047	15.9 ± 1.2	0.626 ± 0.047	0.4	0.016
	V4NCSE..	0.9	3.237	0.1	0.359	19.2 ± 1.2	0.756 ± 0.047	17.3 ± 1.2	0.681 ± 0.047	0.4	0.016
	V4NC4SE..	1.2	4.316	0.15	0.539	19.2 ± 1.2	0.756 ± 0.047	17.3 ± 1.2	0.681 ± 0.047	0.4	0.016
 A10 Lever (mm)	V4NC..	1.3	4.676	0.13	0.467	10.7 ± 0.7	0.421 ± 0.027	9.4 ± 0.7	0.37 ± 0.027	0.2	0.008
	V4NC4..	1.7	6.114	0.2	0.719	10.7 ± 0.7	0.421 ± 0.027	9.4 ± 0.7	0.37 ± 0.027	0.2	0.008
	V4NCE..	1.3	4.676	0.13	0.467	11.5 ± 0.7	0.453 ± 0.027	10.2 ± 0.7	0.401 ± 0.027	0.2	0.008
	V4NC4E..	1.7	6.114	0.2	0.719	11.5 ± 0.7	0.453 ± 0.027	10.2 ± 0.7	0.401 ± 0.027	0.2	0.008
	V4NCS..	1.8	6.474	0.2	0.719	10.7 ± 0.7	0.421 ± 0.027	9.3 ± 0.7	0.366 ± 0.027	0.2	0.008
	V4NC4S..	2	7.193	0.3	1.079	10.7 ± 0.7	0.421 ± 0.027	9.3 ± 0.7	0.366 ± 0.027	0.2	0.008
	V4NCSE..	1.8	6.474	0.2	0.719	11.5 ± 0.7	0.453 ± 0.027	10.1 ± 0.7	0.397 ± 0.027	0.2	0.008
	V4NC4SE..	2	7.193	0.3	1.079	11.5 ± 0.7	0.453 ± 0.027	10.1 ± 0.7	0.397 ± 0.027	0.2	0.008
 AR10 Lever (mm)	V4NC..	1.3	4.676	0.13	0.467	15.8 ± 0.6	0.622 ± 0.023	14.7 ± 0.6	0.579 ± 0.023	0.2	0.008
	V4NC4..	1.9	6.834	0.2	0.719	15.8 ± 0.6	0.622 ± 0.023	14.7 ± 0.6	0.579 ± 0.023	0.2	0.008
	V4NCE..	1.3	4.676	0.13	0.467	16.5 ± 0.6	0.649 ± 0.023	15.4 ± 0.6	0.606 ± 0.023	0.2	0.008
	V4NC4E..	1.9	6.834	0.2	0.719	16.5 ± 0.6	0.649 ± 0.023	15.4 ± 0.6	0.606 ± 0.023	0.2	0.008
	V4NCS..	1.8	6.474	0.2	0.719	15.8 ± 0.6	0.622 ± 0.023	14.7 ± 0.6	0.579 ± 0.023	0.2	0.008
	V4NC4S..	2.1	7.553	0.3	1.079	15.8 ± 0.6	0.622 ± 0.023	14.7 ± 0.6	0.579 ± 0.023	0.2	0.008
	V4NCSE..	1.8	6.474	0.2	0.719	16.5 ± 0.6	0.649 ± 0.023	15.4 ± 0.6	0.606 ± 0.023	0.2	0.008
	V4NC4SE..	2.1	7.553	0.3	1.079	16.5 ± 0.6	0.649 ± 0.023	15.4 ± 0.6	0.606 ± 0.023	0.2	0.008

Operating characteristics shown above are specified from mounting hole centers.

Over travel: Flush with case. (7.8 mm min) The case should not be used as an end stop.

