

## New Special Tool – Front Fog Lamp Removal Tool JD 201

MODEL 1995 MY  
Sedan RangeVIN  
720001-ON**ISSUE:**

A removal tool has been issued for removing front fog lamps.

**ACTION:**

JD 202 is a plastic blade for releasing the spring clips retaining the fog lamp in the vehicle (Illustration 1).

**NOTE:** To remove a fog lamp, always start at the inboard side of the lamp.

1. Slide the tool between the fog lamp and housing on the inboard side of the fog lamp (1, Illustration 1). Gently press the end of the tool away from the fog lamp to release the spring clip on that side.
2. To release the other spring, repeat the operation on the outboard side of the fog lamp (2, Illustration 1), pressing the end of the tool away from the fog lamp.

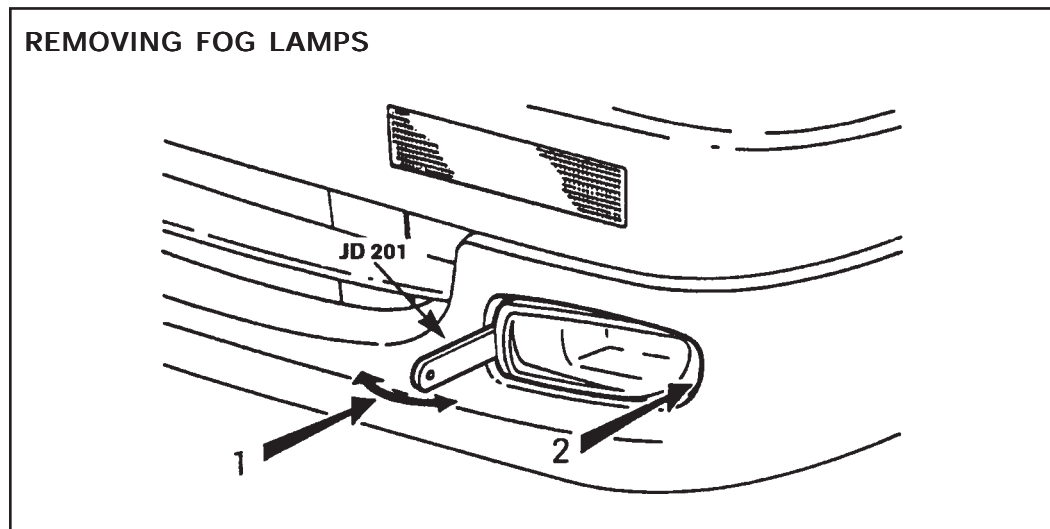

ILLUSTRATION 1